







# TEKNİK ÇİZİM KATALOĐU

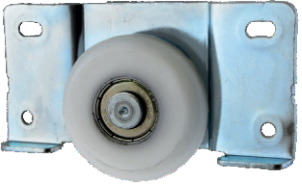
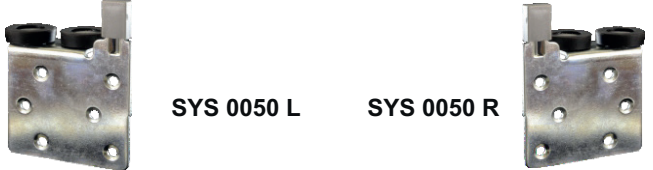

## SYSTEM KARASU

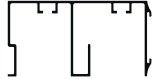
*Profesyonel Çözüm Ortađınız*

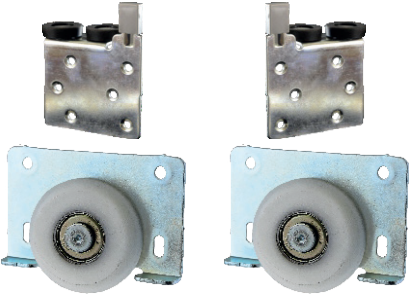
SKS 1203 D

ALT MAKARA/ LOWER ROLLER	BİLGİ/INFORMATION
 <p><b>SYS 1031</b></p>	<p>-İçten çalışan ayarlı ağır sistem sürgü kapak mekanizmasıdır. -İç bükey tasarlanmış makara ile uygulanabilir. -Her kapak için taşıma kapasitesi 60 kg'dır.</p> <p>- It is an adjustable heavy system sliding door mechanism working internally. - It can be applied with concave designed reel. - The carrying capacity for each door is 60 kg.</p>
ÜST KILAVUZ/TOP GUIDE	ALT&ÜST RAYLAR - LOWER TOP RAILS
 <p><b>SYS 0050 L      SYS 0050 R</b></p>	 <p><b>ALT RAY - 0050</b></p>  <p><b>UST RAY 0100</b></p>  <p><b>ALT RAY - 0090</b></p>
1 KAPAK SET / 1 COVER SET	STOP VE YAVAŞLATICILAR / SOFT CLOSERS
	 <p><b>STP 01      STP 03      STP 04      PE 096-1      YM 065</b></p>

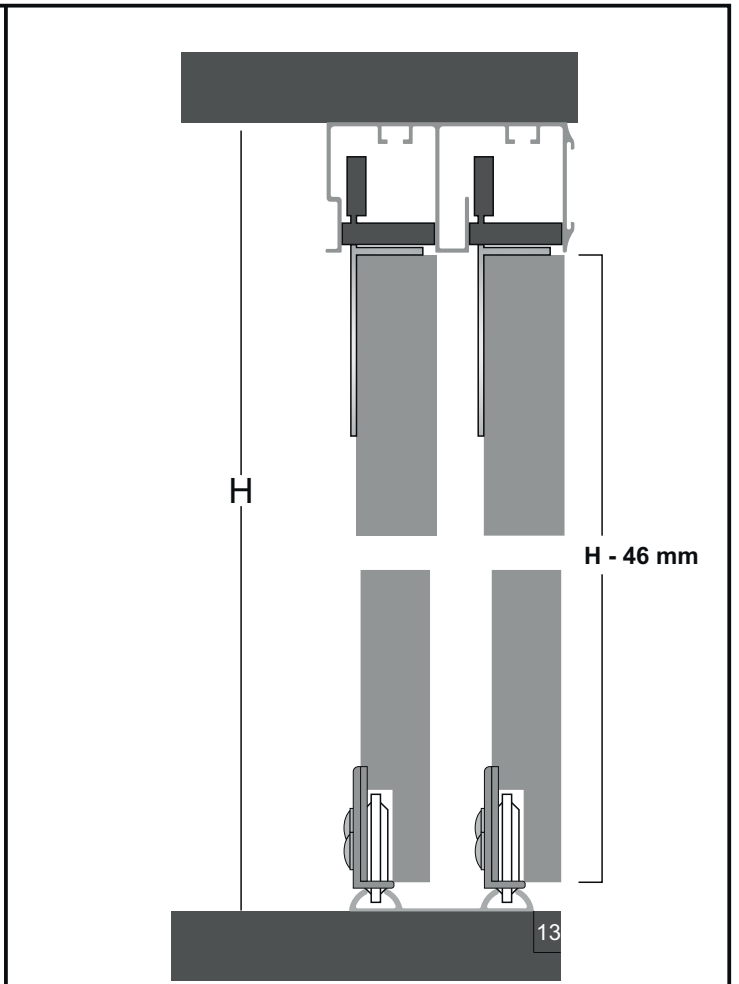
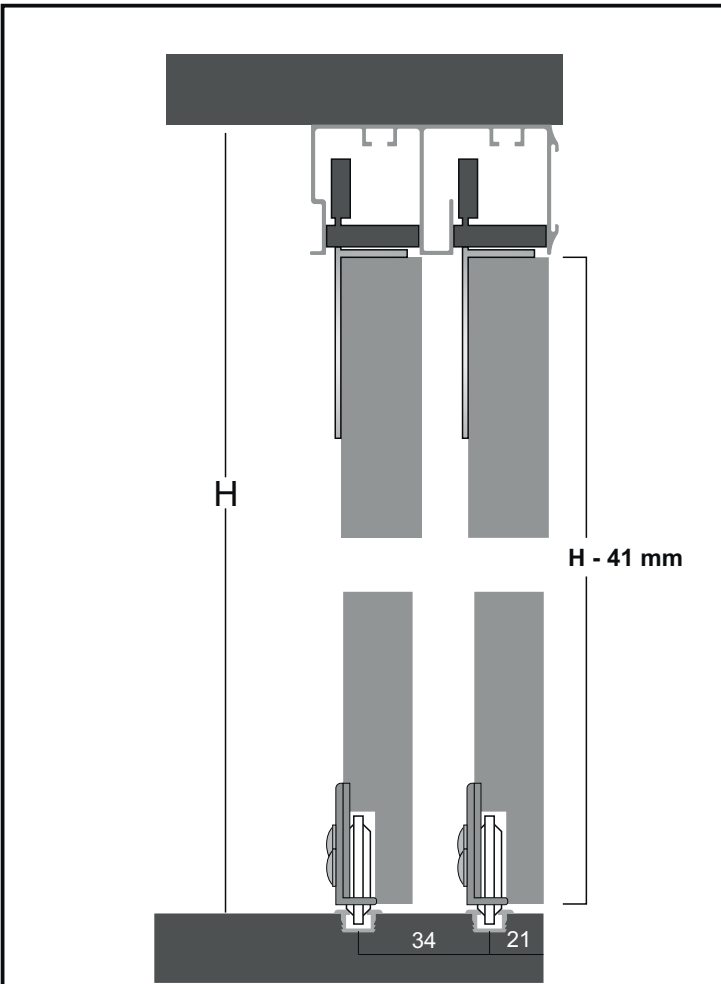

\*18 mm Suntaya göre hazırlanmıştır. *Mounting dimensions prepared according to 18 mm hardboard.*

## MONTAJ ÖLÇÜLERİ

