







TEKNİK ÇİZİM KATALOĐU

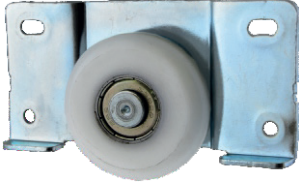

SYSTEM KARASU

Profesyonel Çözüm Ortađınız

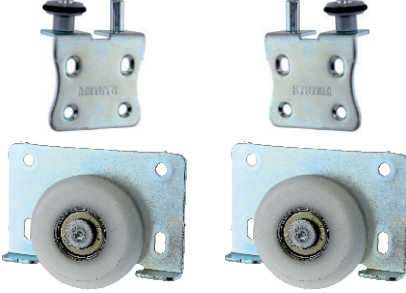
SKS 1200 D

ALT MAKARA/ LOWER ROLLER	BİLGİ/INFORMATION
 <p>SYS 1031</p>	<p>-İçten çalışan ayarlı ağır sistem sürgü kapak mekanizmasıdır. -İç bükey tasarlanmış makara ile uygulanabilir. -Her kapak için taşıma kapasitesi 60 kg'dır.</p> <p>- It is an adjustable heavy system sliding door mechanism working internally. - It can be applied with concave designed reel. - The carrying capacity for each door is 60 kg.</p>
ÜST KILAVUZ/TOP GUIDE	ALT&ÜST RAYLAR - LOWER TOP RAILS
 <p>SYS 0030 L SYS 0030 R</p>	 <p>ALT RAY -0050 UST RAY - 0040</p>  <p>ALT RAY -0090</p>
1 KAPAK SET / 1 COVER SET	STOP VE YAVAŞLATICILAR / SOFT CLOSERS
	 <p>YM 011 PE 096-1</p>

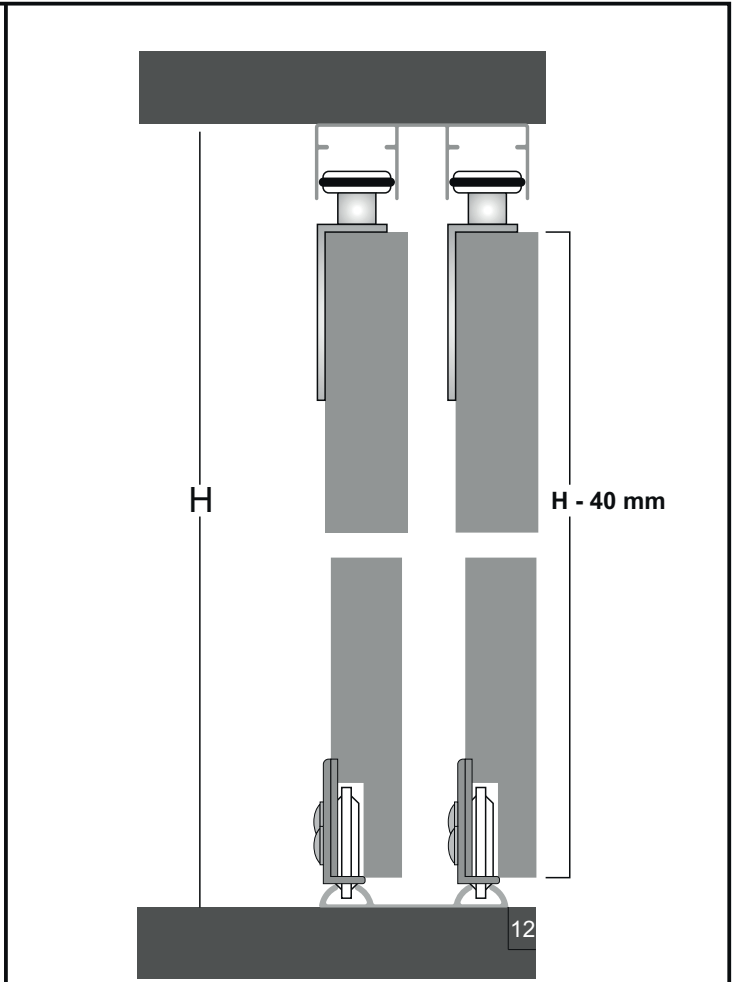
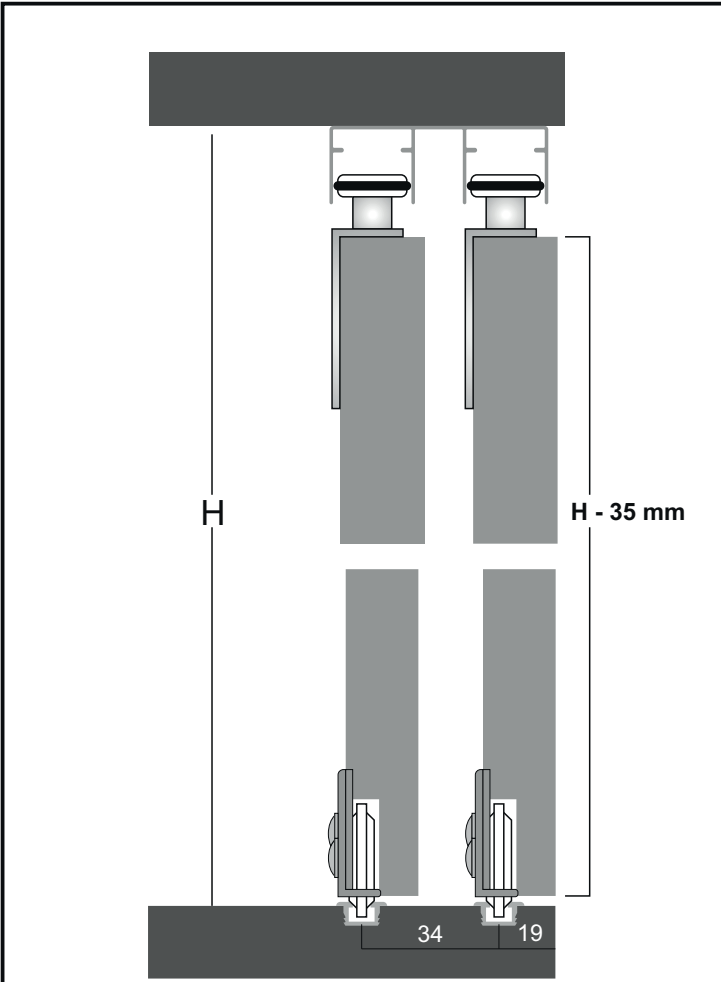

*18 mm Suntaya göre hazırlanmıştır. *Mounting dimensions prepared according to 18 mm hardboard.*

MONTAJ ÖLÇÜLERİ

