

TEKNİK ÇİZİM KATALOĐU



SYSTEM KARASU

Profesyonel Çözüm Ortađınız

SKS 1155 D

ALT MAKARA/ LOWER ROLLER

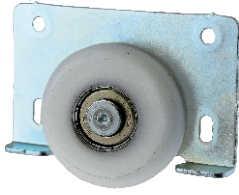

SYS 1021

BİLGİ/INFORMATION

-İçten çalışan ayarlı ağır sistem sürgü kapak mekanizmasıdır.
-İç bükey tasarlanmış makara ile uygulanabilir.
-Her kapak için taşıma kapasitesi 60 kg'dır.

- It is an adjustable heavy system sliding door mechanism working internally.
- It can be applied with concave designed reel.
- The carrying capacity for each door is 60 kg.

ÜST KILAVUZ/TOP GUIDE



SYS 0050 L



SYS 0050 R

ALT&ÜST RAYLAR - LOWER TOP RAILS



ALT RAY - 0050

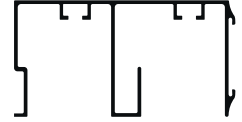

UST RAY 0100



ALT RAY - 0090

1 KAPAK SET / 1 COVER SET

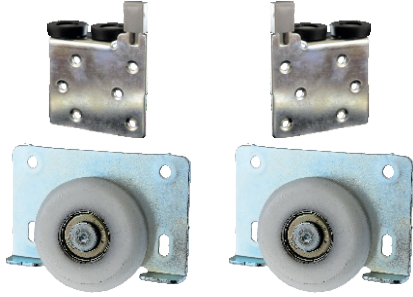

STOP VE YAVAŞLATICILAR / SOFT CLOSERS



STP 01



STP 03



STP 04



PE 096-1



YM 065

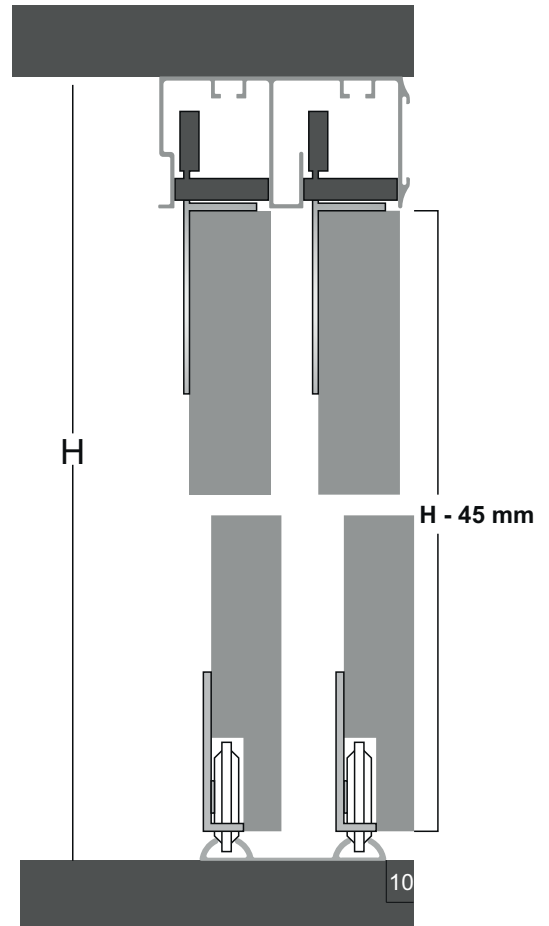
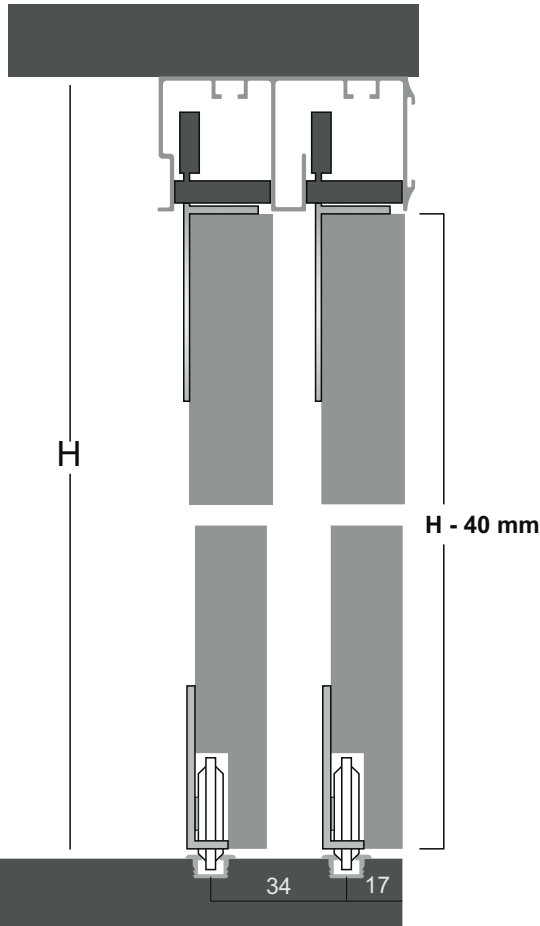

*18 mm Suntaya göre hazırlanmıştır. *Mounting dimensions prepared according to 18 mm hardboard.*

MONTAJ ÖLÇÜLERİ

